

Ulazni uređaji hidroelektrana

- Dovod pod tlakom
- Dovod sa slobodnim vodnim licem

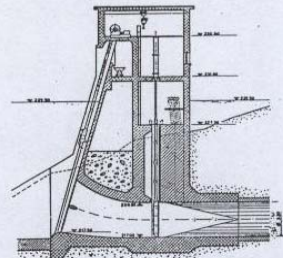

Slika 14.15. Zahvatna građevina HE Rijeka

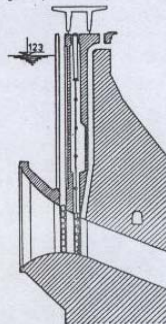

S1.14.6. Detalj ulaza na HE Salakovac

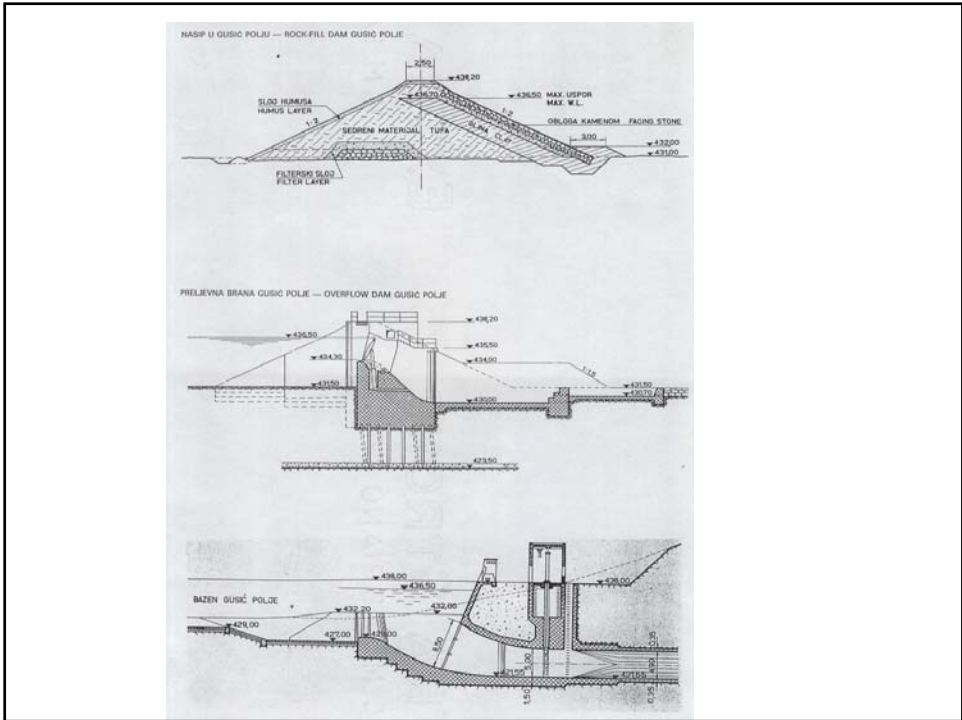
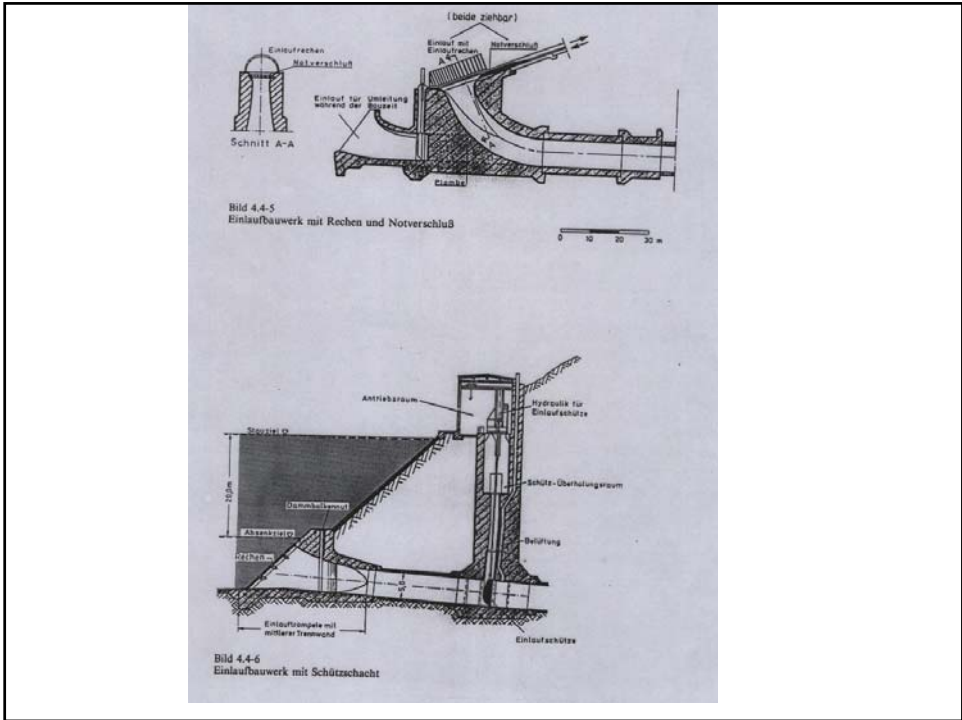

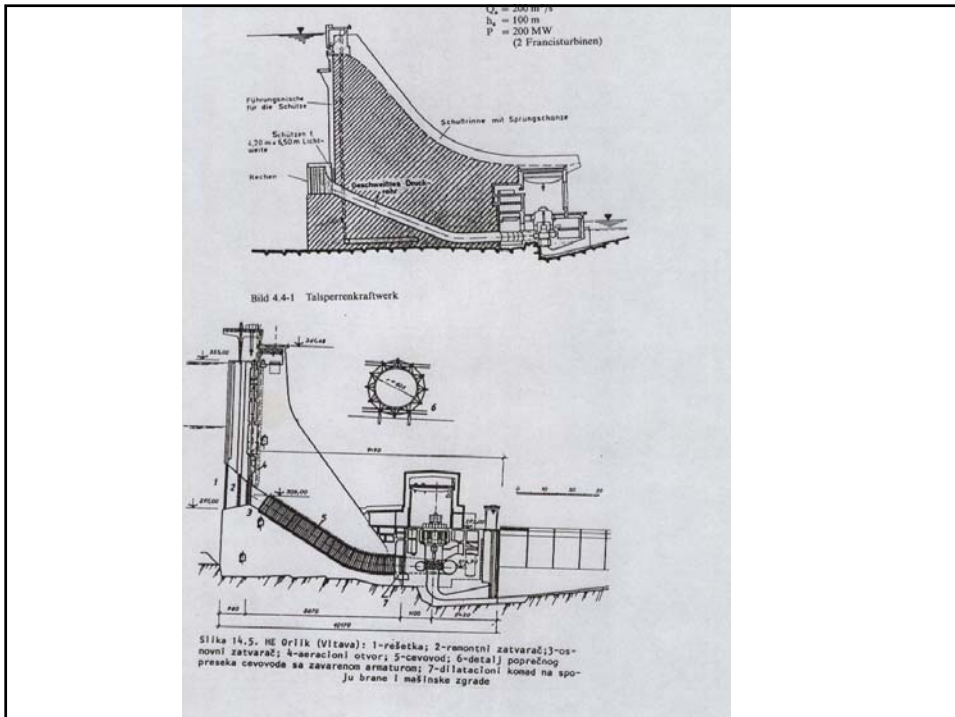
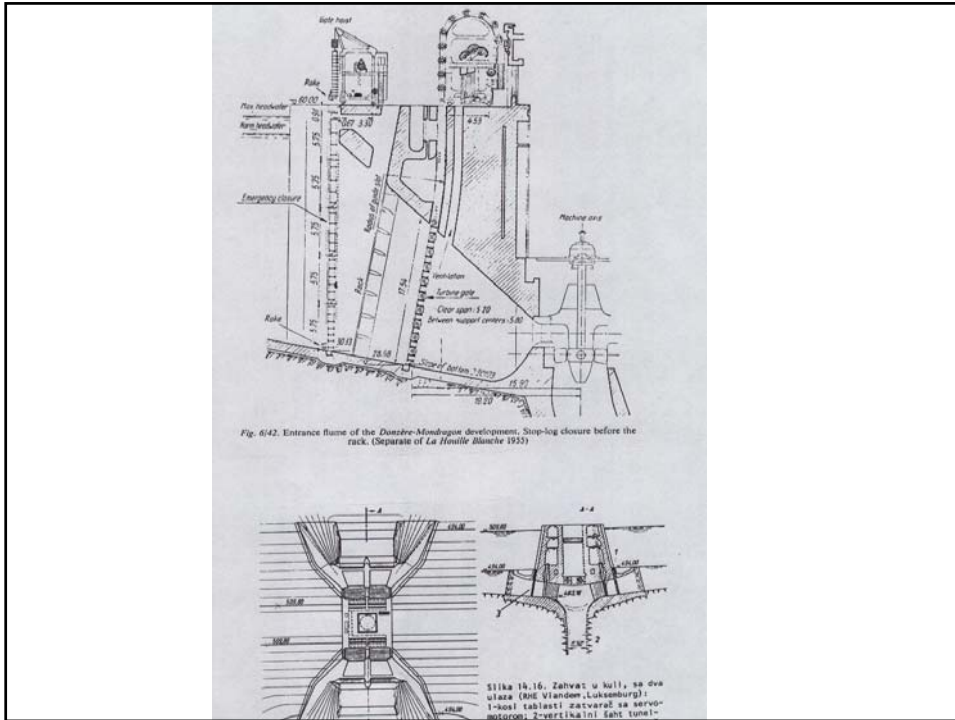

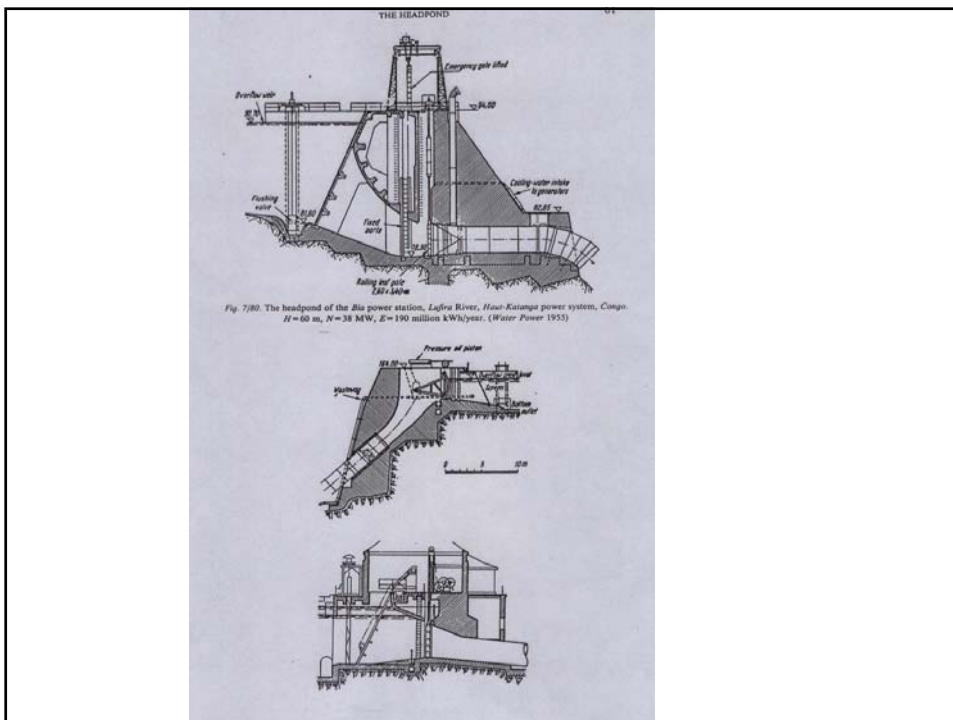
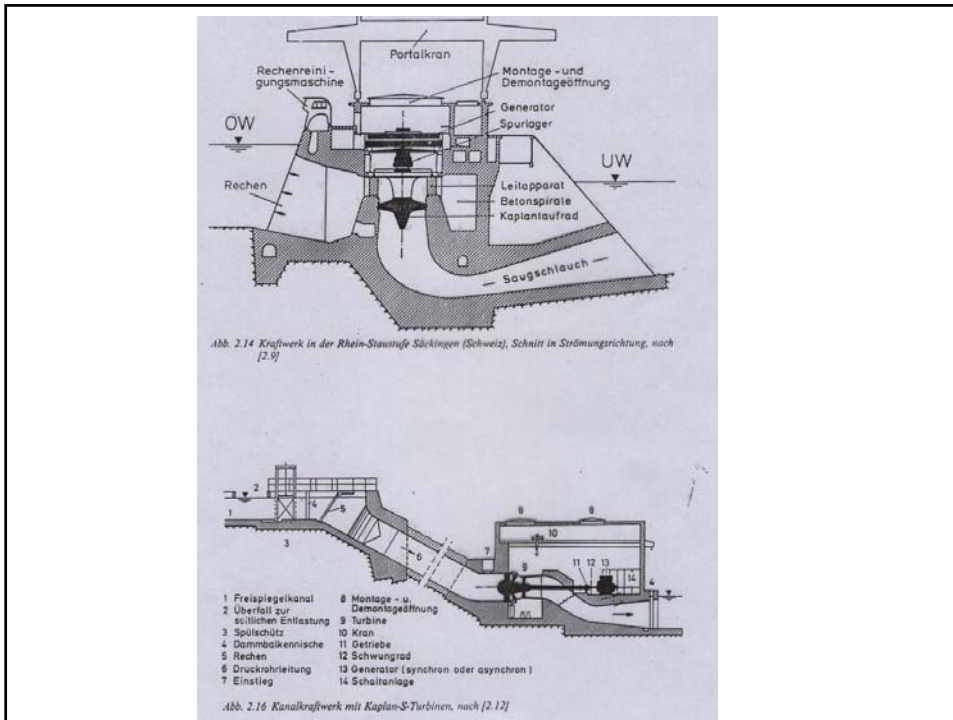

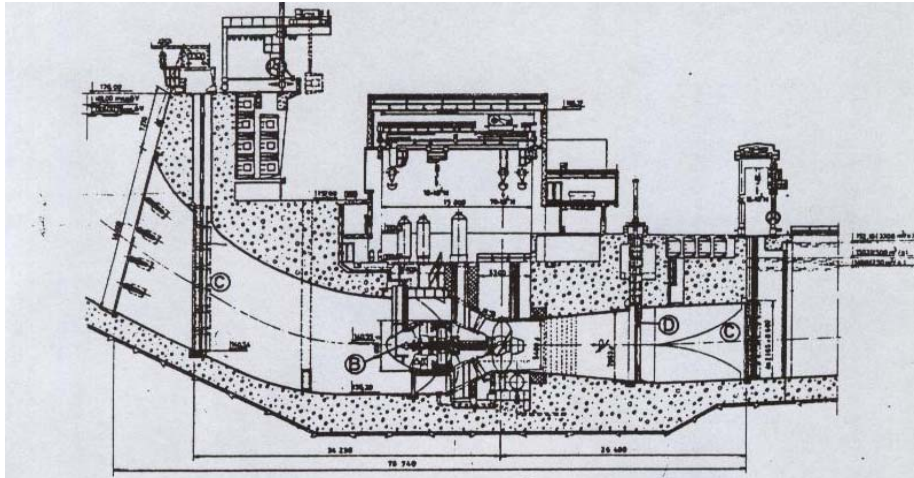

Ⓐ

Uzdužni presjek strojárnice, A – naslage šljunka, B – cijevni agregat, C – gredne zapornice, D – brzi reg

